

REV 版本	DESCRIPTION 描述	DATE 日期
A00	First issue	AUG-01-2007

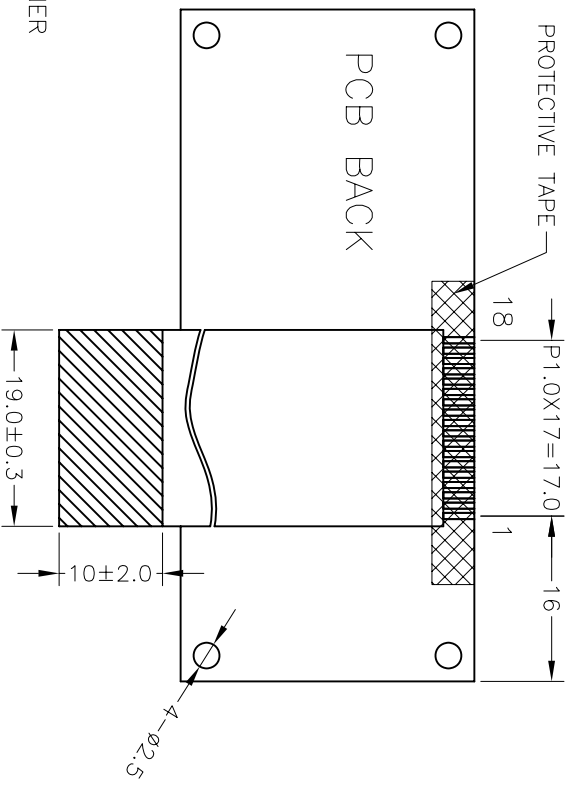

PIN	1	2	3	4	5	6	7	8	9
CONNECTOR	VSS	VDD	V0	A0	R/W	E1	E2	NC	DB0
PIN	10	11	12	13	14	15	16	17	18
CONNECTOR	DB1	DB2	DB3	DB4	DB5	DB6	DB7	LED	LEDK

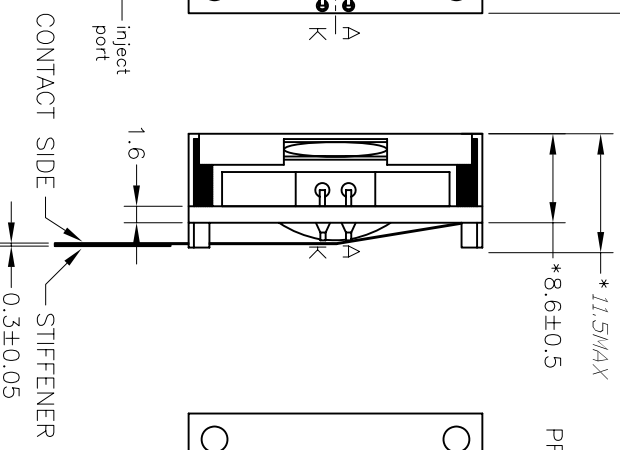
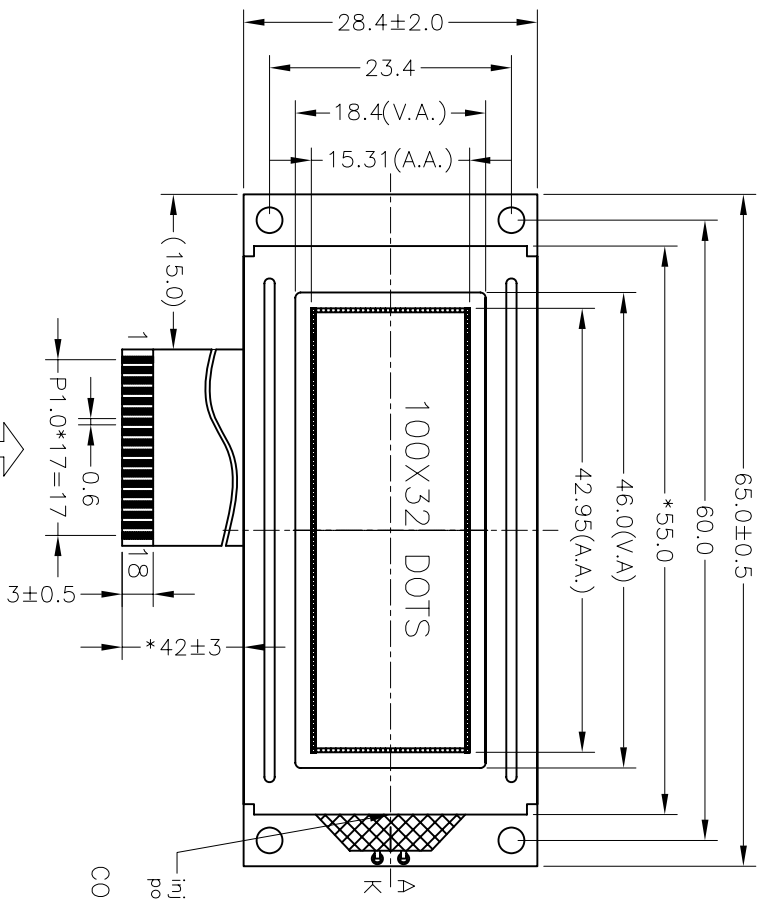
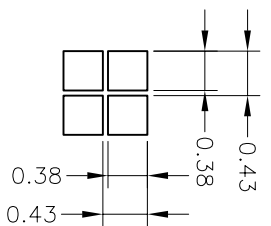

DOT SIZE  
SCALE 10:1

- Specification:
- 1). Driving: Duty:1/32, Bias:1/5, VLCD:4.5V(Ref.), VDD:5.0V
  - 2). Viewing angle: 6 0'clock
  - 3). Display mode: FSTN/Negative/Transmissive/Gray
  - 4). Operating temp.: -0°C~+50°C
  - 5). Storage temp.: -20°C~+70°C
  - 6). Use IC: PT6520
  - 7). Backlight: Side, White
  - 8). Dimensions with mark "\*" are important, with mark "(") are referenced
  - 9). All the raw materials are RoHS compliant.

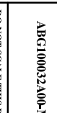

**深圳秋田电子有限公司**  
SHENZHEN AV-DISPLAY CO.,LTD.

PART NO: 零件编号	C/D结构图	PROJECTION 三角法	MODEL NUMBER 模组型号	SCALE: 比例	FTT 适应图面
ABG100032A00-MIW-R			ABG100032A00-MIW-R	SHEET: 页次	1 OF 1
GENERAL TOL: ±0.3 公差			APPROVALS 签字	UNIT UNIT mm	DATE DATE 日期
CHK: DWG:			APP:		

DO NOT SCALE THIS DRAWING.